

SPECIAL SERVICES

STANDARD TUBING

INDEX

Standard Tubing
Page 2

Standard Elbows
Page 3

Standard 90° TY's
Pages 4-5

Standard 45° YL's
Pages 6-7

Standard Double Y's
Page 8

Standard Reducing
Couplings
Page 9

Standard Adapters
Pages 10-11

Methods of Joining
Pages 12-13

Inlet Valves for
Vacuum Systems
Page 14

Standard Long
Radius Bends
Page 15

Bend Information
Page 16

Our standard stock is in
20 ft. lengths, but we will cut
to your specifications.

OD = Outside Diameter
ID = Inside Diameter

All reference dimensions are
nominal



Leading Supplier of Tubing, Bends & Fittings for Air Handling Systems

Standard tubing, bends and fittings / Custom tube fabrication services

**We're experts in solving your air handling problems
with specially designed tubular components.**

Our standard catalog items include sizes from 1-1/2" OD through 14" OD in carbon, zinc-coated (galvanized) and stainless steel, as well as aluminum. Plus, fast delivery is available on a wide selection of in-stock tubing, bends and fittings. We'll also make every effort to meet emergency requirements for non-stock items.

SPECIAL SERVICES

Catalog Part Variations:

Our standard items don't meet your needs? Contact us for immediate assistance. Custom tube fabrication services are available to meet your exact specifications.

Inside and Outside Diameter Polishing:

Provides smooth ID (180 grit) and OD (150 grit) surfaces. For 2" - 6" OD Long Radius Bends only.

Ceramic Coating:

A wear-resistant ceramic compound, applied to the exterior surface, which significantly extends the life of the part in systems conveying highly abrasive materials.

TERMINOLOGY

Gauge:

This term is used when referring to the wall thickness of tubing. This catalog has parts made from 11, 12, 14, and 16 gauge material.

| Gauge | Nominal wall thickness |
|-------|------------------------|
| 11 | .120" |
| 12 | .109" |
| 14 | .083" |
| 16 | .065" |

Schedule:

This term is used when referring to the wall thickness of pipe.

Alloys:

Carbon is 1006-1010 ERW. Aluminum is 6061/6063 extruded. Stainless is 304.

STANDARD TUBING

Part Number By Material

| OD | GAUGE | NOMINAL WALL THICKNESS | CARBON | ZINC/GALV. COATED | STAINLESS | ALUMINUM |
|--------|-------|------------------------|-----------|-----------------------|-----------|------------|
| 1-1/2" | 16 | .065" | 16WT150C | 16WT150Z [^] | 16WT150S | 16ST150A |
| 1-1/2" | 11 | .120" | 11WT150C | 11WT150Z [^] | 11WT150S | 11ST150A |
| 2" | 16 | .065" | 16WT200C | 16WT200Z | 16WT200S | 16ST200A |
| 2" | 11 | .120" | 11WT200C | 11WT200Z | 11WT200S | 11ST200A |
| 2-1/8" | 16 | .065" | 16WT212C | 16WT212Z | 16WT212S | 16ST212A |
| 2-1/8" | 11 | .120" | 11WT212C | 11WT212Z | 11WT212S | 11ST212A |
| 2-1/2" | 16 | .065" | 16WT250C | 16WT250Z | 16WT250S | 16ST250A |
| 2-1/2" | 11 | .120" | 11WT250C | 11WT250Z | 11WT250S | 11ST250A |
| 3" | 16 | .065" | 16WT300C | 16WT300Z | 16WT300S | 16ST300A |
| 3" | 11 | .120" | 11WT300C | 11WT300Z | 11WT300S | 11ST300A |
| 3-1/2" | 16 | .065" | 16WT350C | 16WT350Z | 16WT350S | 16ST350A |
| 3-1/2" | 11 | .120" | 11WT350C | 11WT350Z | 11WT350S | 11ST350A |
| 4" | 16 | .065" | 16WT400C | 16WT400Z | 16WT400S | 16ST400A |
| 4" | 11 | .120" | 11WT400C | 11WT400Z | 11WT400S | 11ST400A |
| 5" | 14 | .083" | 14WT500C | 14WT500Z | 14WT500S | 14ST500A |
| 5" | 11 | .120" | 11WT500C | 11WT500Z | 11WT500S | 11ST500A |
| 6" | 14 | .083" | 14WT600C | 14WT600Z | 14WT600S | 14ST600A |
| 6" | 11 | .120" | 11WT600C | 11WT600Z | 11WT600S | 11ST600A |
| 8" | 14 | .083" | 14WT800C | 14WT800Z | 14WT800S | 14ST800A |
| 8" | 11 | .120" | 11WT800C | 11WT800Z | 11WT800S | 11ST800A |
| 10" | 12 | .109" | 12WT1000C | 12WT1000Z | 12WT1000S | 12ST1000A+ |
| 12" | 12 | .109" | 12WT1200C | 12WT1200Z | 12WT1200S | 12ST1200A+ |
| 14" | 12 | .109" | 12WT1400C | 12WT1400Z | * | * |

[^] 10 ft. lengths

+ 13 Gauge

* Quotation basis only



Standard Elbows

11 Gauge Elbows Available / 30° and 60° Elbows Available

STANDARD ELBOWS

STANDARD RADIUS ELBOWS

| A(OD) | B(CLR) | 45° PART NO. | C | TAN. | 90° PART NO. | C | GAUGE |
|--------|---------|--------------|-----------|--------|--------------|---------|-------|
| 2-1/8" | 5" | EL-211 | 4-5/16" | 2" | EL-212 | 7" | 16 |
| 2-1/2" | 6" | EL-251 | 4-1/2" | 2" | EL-252 | 8" | 16 |
| 3" | 7-1/2" | EL-301 | 5-1/8" | 2" | EL-302 | 9-1/2" | 16 |
| 3-1/2" | 8-3/4" | EL-351 | 5-5/8" | 2" | EL-352 | 10-1/4" | 16 |
| 4" | 10" | EL-401 | 6-1/8" | 2" | EL-402 | 12" | 16 |
| 5" | 12-1/2" | EL-501 | 7-13/16" | 2-5/8" | EL-502 | 15-1/8" | 14 |
| 6" | 15" | EL-601 | 9-15/32" | 3-1/4" | EL-602 | 18-1/4" | 14 |
| 8" | 20" | EL-801 | 12-17/32" | 4-1/4" | EL-802 | 24-1/4" | 14 |
| 10" | 32" | EL-1001* | 28-1/4" | 15" | EL-1002* | 47" | 12 |
| 12" | 36" | EL-1201** | 21-5/32" | 6-1/4" | EL-1202** | 42-1/4" | 12 |
| 14" | 36" | EL-1401** | 22-5/32" | 7-1/4" | EL-1402** | 43-1/4" | 12 |

* Stainless Parts are Segmented

** Segmented

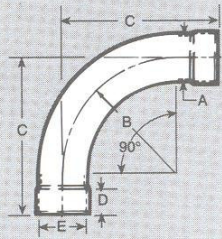
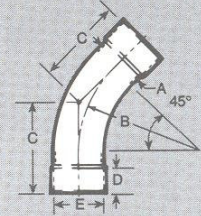

SHORT RADIUS ELBOWS

| A(OD) | B(CLR) | 45° PART NO. | C | TAN. | 90° PART NO. | C | GAUGE |
|--------|--------|--------------|----------|--------|--------------|---------|-------|
| 2-1/8" | 3-1/2" | SR-211 | 3-7/16" | 2" | SR-212 | 5-1/2" | 16 |
| 2-1/2" | 4" | SR-251 | 3-21/32" | 2" | SR-252 | 6" | 16 |
| 3" | 4-1/2" | SR-341 | 3-7/8" | 2" | SR-342 | 6-1/2" | 16 |
| 3-1/2" | 5" | SR-351 | 4-1/16" | 2" | SR-352 | 7" | 16 |
| 4" | 6" | SR-441 | 4-1/2" | 2" | SR-442 | 8" | 16 |
| 5" | 7-1/2" | SR-541 | 5-23/32" | 2-5/8" | SR-542 | 10-1/8" | 14 |
| 6" | 9" | SR-641 | 6-31/32" | 3-1/4" | SR-642 | 12-1/4" | 14 |
| 8" | 12" | SR-841 | 9-7/32" | 4-1/4" | SR-842 | 16-1/4" | 14 |

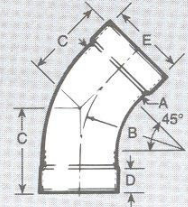

D Expansion Depth 1-1/4" thru 4" OD, 1-1/2" for 5" and 6" OD

E Inside Diameter (ID) = A Outside Diameter (OD)

CLR = Center Line Radius

TAN. = Tangent Length

All reference dimensions are nominal.

Catalog Part Variations Available Upon Request.

Expanded Ends standard through 6" size, also available Expanded One End.

Straight Ends available on all sizes by request.

NOTE: FOR LONG RADIUS BENDS SEE PAGE 15.

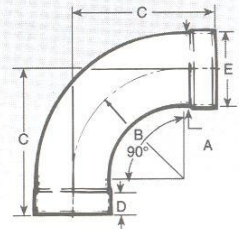

STANDARD 90° TY'S

2-1/8" OD to 4" OD
16 GAUGE
MATERIAL

5" OD to 8" OD
14 GAUGE
MATERIAL

10" OD to 14" OD
12 GAUGE
MATERIAL

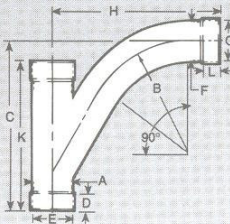
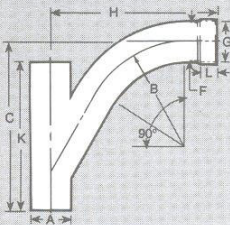

Standard 90° TY's

11 Gauge TY's Available

| PART NO. | SIZE | A(OD) | B | C | F(OD) | H | K |
|----------|-----------------|--------|---------|-----------|--------|-----------|---------|
| TY-215 | 2-1/8" | 2-1/8" | 5" | 9-5/32" | 2-1/8" | 8-13/16" | 9-1/2" |
| TY-255 | 2-1/2" x 2-1/8" | 2-1/2" | 5" | 9-11/32" | 2-1/8" | 9" | 10" |
| TY-256 | 2-1/2" | 2-1/2" | 6" | 10-1/2" | 2-1/2" | 10-1/32" | 10" |
| TY-305 | 3" x 2-1/8" | 3" | 5" | 9-19/32" | 2-1/8" | 9-1/4" | 10-1/2" |
| TY-306 | 3" x 2-1/2" | 3" | 6" | 10-3/4" | 2-1/2" | 10-9/32" | 10-1/2" |
| TY-307 | 3" | 3" | 7-1/2" | 12-3/8" | 3" | 11-25/32" | 11-1/2" |
| TY-355 | 3-1/2" x 2-1/8" | 3-1/2" | 5" | 9-27/32" | 2-1/8" | 9-1/2" | 11" |
| TY-356 | 3-1/2" x 2-1/2" | 3-1/2" | 6" | 11" | 2-1/2" | 10-17/32" | 11" |
| TY-357 | 3-1/2" x 3" | 3-1/2" | 7-1/2" | 12-5/8" | 3" | 12-1/32" | 13" |
| TY-358 | 3-1/2" | 3-1/2" | 8-3/4" | 14-1/8" | 3-1/2" | 13-11/32" | 13" |
| TY-405 | 4" x 2-1/8" | 4" | 5" | 10-3/32" | 2-1/8" | 9-3/4" | 12" |
| TY-406 | 4" x 2-1/2" | 4" | 6" | 11-1/4" | 2-1/2" | 10-25/32" | 12" |
| TY-407 | 4" x 3" | 4" | 7-1/2" | 12-7/8" | 3" | 12-9/32" | 12" |
| TY-408 | 4" x 3-1/2" | 4" | 8-3/4" | 14-3/8" | 3-1/2" | 13-19/32" | 14" |
| TY-409 | 4" | 4" | 10" | 15-7/8" | 4" | 14-29/32" | 14" |
| TY-505 | 5" x 2-1/8" | 5" | 5" | 10-19/32" | 2-1/8" | 10-1/4" | 13" |
| TY-506 | 5" x 2-1/2" | 5" | 6" | 11-3/4" | 2-1/2" | 11-9/32" | 13" |
| TY-507 | 5" x 3" | 5" | 7-1/2" | 13-3/8" | 3" | 12-25/32" | 15-1/2" |
| TY-508 | 5" x 3-1/2" | 5" | 8-3/4" | 14-7/8" | 3-1/2" | 14-3/32" | 15-1/2" |
| TY-509 | 5" x 4" | 5" | 10" | 16-3/8" | 4" | 15-13/32" | 15-1/2" |
| TY-515 | 5" | 5" | 12-1/2" | 19-3/8" | 5" | 18-5/8" | 18-1/2" |
| TY-605 | 6" x 2-1/8" | 6" | 5" | 11-3/32" | 2-1/8" | 10-3/4" | 15" |
| TY-606 | 6" x 2-1/2" | 6" | 6" | 12-1/4" | 2-1/2" | 11-25/32" | 15" |
| TY-607 | 6" x 3" | 6" | 7-1/2" | 13-7/8" | 3" | 13-9/32" | 15" |
| TY-608 | 6" x 3-1/2" | 6" | 8-3/4" | 15-3/8" | 3-1/2" | 14-19/32" | 17" |
| TY-609 | 6" x 4" | 6" | 10" | 16-7/8" | 4" | 15-29/32" | 17" |
| TY-614 | 6" x 5" | 6" | 12-1/2" | 19-7/8" | 5" | 19-1/8" | 21" |
| TY-615 | 6" | 6" | 15" | 22-7/8" | 6" | 22-11/32" | 21" |

D Expansion Depth 1-1/4" thru 4" OD, 1-1/2" for 5" and 6" OD

E Inside Diameter (ID) = A Outside Diameter (OD)

G Inside Diameter (ID) = F Outside Diameter (OD)

L Expansion Depth 1-1/4" thru 4" OD, 1-1/2" for 5" and 6" OD

All reference dimensions are nominal.

Catalog Part Variations Available Upon Request.

Expanded Ends standard through 6" size.

Straight and Expanded combinations available.

Straight Ends available on all sizes by request.



Standard 90° TY's

11 Gauge TY's Available

| PART NO. | SIZE | A(OD) | B | C | F(OD) | H | K |
|----------|--------------|-------|---------|----------|--------|-----------|-----|
| TY-805 | 8" x 2-1/8" | 8" | 5" | 12-3/32" | 2-1/8" | 11-3/4" | 18" |
| TY-806 | 8" x 2-1/2" | 8" | 6" | 13-1/4" | 2-1/2" | 12-25/32" | 18" |
| TY-807 | 8" x 3" | 8" | 7-1/2" | 14-7/8" | 3" | 14-9/32" | 18" |
| TY-808 | 8" x 3-1/2" | 8" | 8-3/4" | 16-3/8" | 3-1/2" | 15-19/32" | 21" |
| TY-809 | 8" x 4" | 8" | 10" | 17-7/8" | 4" | 16-29/32" | 21" |
| TY-814 | 8" x 5" | 8" | 12-1/2" | 20-7/8" | 5" | 20-1/8" | 24" |
| TY-815 | 8" x 6" | 8" | 15" | 23-7/8" | 6" | 23-11/32" | 24" |
| TY-816 | 8" | 8" | 20" | 29-7/8" | 8" | 29-17/32" | 29" |
| TY-1005 | 10" x 2-1/8" | 10" | 5" | 13-3/32" | 2-1/8" | 12-3/4" | 21" |
| TY-1006 | 10" x 2-1/2" | 10" | 6" | 14-1/4" | 2-1/2" | 13-25/32" | 21" |
| TY-1007 | 10" x 3" | 10" | 7-1/2" | 15-7/8" | 3" | 15-9/32" | 21" |
| TY-1008 | 10" x 3-1/2" | 10" | 8-3/4" | 17-3/8" | 3-1/2" | 16-17/32" | 24" |
| TY-1009 | 10" x 4" | 10" | 10" | 18-7/8" | 4" | 17-29/32" | 24" |
| TY-1014 | 10" x 5" | 10" | 12-1/2" | 21-7/8" | 5" | 21-1/8" | 24" |
| TY-1015 | 10" x 6" | 10" | 15" | 24-7/8" | 6" | 24-11/32" | 28" |
| TY-1016 | 10" x 8" | 10" | 20" | 30-7/8" | 8" | 30-17/32" | 32" |
| TY-1017 | 10" | 10" | 32" | 40-3/8" | 10" | 42-25/32" | 36" |
| TY-1205 | 12" x 2-1/8" | 12" | 5" | 14-3/32" | 2-1/8" | 13-3/4" | 24" |
| TY-1206 | 12" x 2-1/2" | 12" | 6" | 15-1/4" | 2-1/2" | 14-25/32" | 24" |
| TY-1207 | 12" x 3" | 12" | 7-1/2" | 16-7/8" | 3" | 16-9/32" | 24" |
| TY-1208 | 12" x 3-1/2" | 12" | 8-3/4" | 18-3/8" | 3-1/2" | 17-19/32" | 27" |
| TY-1209 | 12" x 4" | 12" | 10" | 19-7/8" | 4" | 18-29/32" | 27" |
| TY-1214 | 12" x 5" | 12" | 12-1/2" | 22-7/8" | 5" | 22-1/8" | 27" |
| TY-1215 | 12" x 6" | 12" | 15" | 25-7/8" | 6" | 25-11/32" | 31" |
| TY-1216 | 12" x 8" | 12" | 20" | 31-7/8" | 8" | 31-17/32" | 35" |
| TY-1217 | 12" x 10" | 12" | 32" | 41-3/8" | 10" | 43-25/32" | 39" |
| TY-1218 | 12" | 12" | 36"*** | 46-7/8" | 12" | 49-1/8" | 43" |
| TY-1416 | 14" x 8" | 14" | 20" | 32-7/8" | 8" | 32-17/32" | 38" |
| TY-1417 | 14" x 10" | 14" | 32" | 42-3/8" | 10" | 44-25/32" | 42" |
| TY-1418 | 14" x 12" | 14" | 36"*** | 47-7/8" | 12" | 50-1/8" | 46" |
| TY-1419 | 14" | 14" | 36"*** | 51-3/8" | 14" | 50-3/4" | 52" |

**Segmented

G Inside Diameter (ID) = F Outside Diameter (OD)
 L Expansion Depth 1-1/4" thru 4" OD, 1-1/2" for 5" and 6" OD

All reference dimensions are nominal.
 Catalog Part Variations Available Upon Request.

Expanded Ends standard through 6" size.

Straight Ends available on all sizes by request.

STANDARD 90° TY'S

2-1/8" OD to 4" OD
16 GAUGE MATERIAL

5" OD to 8" OD
14 GAUGE MATERIAL

10" OD to 14" OD
12 GAUGE MATERIAL

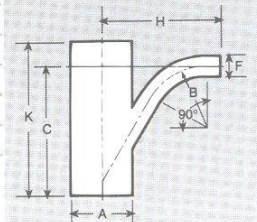
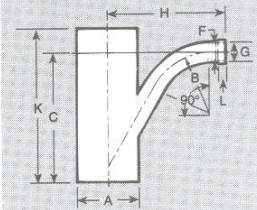

STANDARD 45° YL'S

**2-1/8" OD to 4" OD
16 GAUGE
MATERIAL**

**5" OD to 8" OD
14 GAUGE
MATERIAL**

**10" OD to 14" OD
12 GAUGE
MATERIAL**

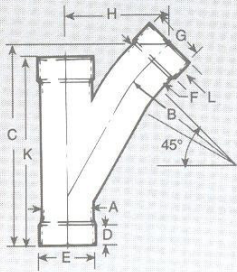
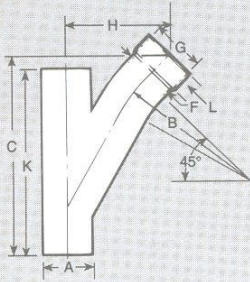

Standard 45° YL's

11 Gauge YL's Available

| PART NO. | SIZE | A(OD) | B | C | F(OD) | H | K |
|----------|-----------------|--------|---------|-----------|--------|-----------|---------|
| YL-2151 | 2-1/8" | 2-1/8" | 5" | 9-3/32" | 2-1/8" | 4-11/16" | 9-1/2" |
| YL-2551 | 2-1/2" x 2-1/8" | 2-1/2" | 5" | 9-9/32" | 2-1/8" | 4-7/8" | 10" |
| YL-2561 | 2-1/2" | 2-1/2" | 6" | 10-5/32" | 2-1/2" | 5-3/16" | 10" |
| YL-3051 | 3" x 2-1/8" | 3" | 5" | 9-17/32" | 2-1/8" | 5-1/8" | 10-1/2" |
| YL-3061 | 3" x 2-1/2" | 3" | 6" | 10-13/32" | 2-1/2" | 5-7/16" | 10-1/2" |
| YL-3071 | 3" | 3" | 7-1/2" | 11-19/32" | 3" | 5-29/32" | 11-1/2" |
| YL-3551 | 3-1/2" x 2-1/8" | 3-1/2" | 5" | 9-25/32" | 2-1/8" | 5-3/8" | 11" |
| YL-3561 | 3-1/2" x 2-1/2" | 3-1/2" | 6" | 10-21/32" | 2-1/2" | 5-11/16" | 11" |
| YL-3571 | 3-1/2" x 3" | 3-1/2" | 7-1/2" | 11-27/32" | 3" | 6-5/32" | 13" |
| YL-3581 | 3-1/2" | 3-1/2" | 8-3/4" | 12-31/32" | 3-1/2" | 6-9/16" | 13" |
| YL-4051 | 4" x 2-1/8" | 4" | 5" | 10-1/32" | 2-1/8" | 5-5/8" | 12" |
| YL-4061 | 4" x 2-1/2" | 4" | 6" | 10-29/32" | 2-1/2" | 5-15/16" | 12" |
| YL-4071 | 4" x 3" | 4" | 7-1/2" | 12-3/32" | 3" | 6-13/32" | 12" |
| YL-4081 | 4" x 3-1/2" | 4" | 8-3/4" | 13-7/32" | 3-1/2" | 6-13/16" | 14" |
| YL-4091 | 4" | 4" | 10" | 14-11/32" | 4" | 7-1/4" | 14" |
| YL-5051 | 5" x 2-1/8" | 5" | 5" | 10-17/32" | 2-1/8" | 6-1/8" | 13" |
| YL-5061 | 5" x 2-1/2" | 5" | 6" | 11-13/32" | 2-1/2" | 6-7/16" | 13" |
| YL-5071 | 5" x 3" | 5" | 7-1/2" | 12-19/32" | 3" | 6-29/32" | 15-1/2" |
| YL-5081 | 5" x 3-1/2" | 5" | 8-3/4" | 13-23/32" | 3-1/2" | 7-5/16" | 15-1/2" |
| YL-5091 | 5" x 4" | 5" | 10" | 14-27/32" | 4" | 7-3/4" | 15-1/2" |
| YL-5151 | 5" | 5" | 12-1/2" | 17-9/16" | 5" | 9" | 18-1/2" |
| YL-6051 | 6" x 2-1/8" | 6" | 5" | 11-1/32" | 2-1/8" | 6-5/8" | 15" |
| YL-6061 | 6" x 2-1/2" | 6" | 6" | 11-29/32" | 2-1/2" | 6-15/16" | 15" |
| YL-6071 | 6" x 3" | 6" | 7-1/2" | 13-3/32" | 3" | 7-13/32" | 15" |
| YL-6081 | 6" x 3-1/2" | 6" | 8-3/4" | 14-7/32" | 3-1/2" | 7-13/16" | 17" |
| YL-6091 | 6" x 4" | 6" | 10" | 15-11/32" | 4" | 8-1/4" | 17" |
| YL-6141 | 6" x 5" | 6" | 12-1/2" | 18-1/16" | 5" | 9-1/2" | 21" |
| YL-6151 | 6" | 6" | 15" | 20-25/32" | 6" | 10-25/32" | 21" |

D Expansion Depth 1-1/4" thru 4" OD, 1-1/2" for 5" and 6" OD

E Inside Diameter (ID) = A Outside Diameter (OD)

G Inside Diameter (ID) = F Outside Diameter (OD)

L Expansion Depth 1-1/4" thru 4" OD, 1-1/2" for 5" and 6" OD

All reference dimensions are nominal.

Catalog Part Variations Available Upon Request.

Expanded Ends standard through 6" size.

Straight and Expanded combinations available.

Straight Ends available on all sizes by request.



Standard 45° YL's

11 Gauge YL's Available

| PART NO. | SIZE | A(OD) | B | C | F(OD) | H | K |
|----------|--------------|-------|---------|-----------|--------|-----------|-----|
| YL-8051 | 8" x 2-1/8" | 8" | 5" | 12-1/32" | 2-1/8" | 7-5/8" | 18" |
| YL-8061 | 8" x 2-1/2" | 8" | 6" | 12-29/32" | 2-1/2" | 7-15/16" | 18" |
| YL-8071 | 8" x 3" | 8" | 7-1/2" | 14-3/32" | 3" | 8-13/32" | 18" |
| YL-8081 | 8" x 3-1/2" | 8" | 8-3/4" | 15-7/32" | 3-1/2" | 8-13/16" | 21" |
| YL-8091 | 8" x 4" | 8" | 10" | 16-11/32" | 4" | 9-1/4" | 21" |
| YL-8141 | 8" x 5" | 8" | 12-1/2" | 19-1/16" | 5" | 10-1/2" | 24" |
| YL-8151 | 8" x 6" | 8" | 15" | 21-25/32" | 6" | 11-25/32" | 24" |
| YL-8161 | 8" | 8" | 20" | 27" | 8" | 14-5/32" | 29" |
| YL-10051 | 10" x 2-1/8" | 10" | 5" | 13-1/32" | 2-1/8" | 8-5/8" | 21" |
| YL-10061 | 10" x 2-1/2" | 10" | 6" | 13-29/32" | 2-1/2" | 8-15/16" | 21" |
| YL-10071 | 10" x 3" | 10" | 7-1/2" | 15-3/32" | 3" | 9-13/32" | 21" |
| YL-10081 | 10" x 3-1/2" | 10" | 8-3/4" | 16-7/32" | 3-1/2" | 9-13/16" | 24" |
| YL-10091 | 10" x 4" | 10" | 10" | 17-11/32" | 4" | 10-1/4" | 24" |
| YL-10141 | 10" x 5" | 10" | 12-1/2" | 20-1/16" | 5" | 11-1/2" | 24" |
| YL-10151 | 10" x 6" | 10" | 15" | 22-3/4" | 6" | 12-25/32" | 28" |
| YL-10161 | 10" x 8" | 10" | 20" | 28" | 8" | 15-5/32" | 32" |
| YL-10171 | 10" | 10" | 32" | 34-11/16" | 10" | 18-5/8" | 36" |
| YL-12051 | 12" x 2-1/8" | 12" | 5" | 14-1/32" | 2-1/8" | 9-5/8" | 24" |
| YL-12061 | 12" x 2-1/2" | 12" | 6" | 14-29/32" | 2-1/2" | 9-31/32" | 24" |
| YL-12071 | 12" x 3" | 12" | 7-1/2" | 16-3/32" | 3" | 10-13/32" | 24" |
| YL-12081 | 12" x 3-1/2" | 12" | 8-3/4" | 17-7/32" | 3-1/2" | 10-13/16" | 27" |
| YL-12091 | 12" x 4" | 12" | 10" | 18-11/32" | 4" | 11-1/4" | 27" |
| YL-12141 | 12" x 5" | 12" | 12-1/2" | 21-1/16" | 5" | 12-1/2" | 27" |
| YL-12151 | 12" x 6" | 12" | 15" | 23-3/4" | 6" | 13-25/32" | 31" |
| YL-12161 | 12" x 8" | 12" | 20" | 29" | 8" | 16-5/32" | 35" |
| YL-12171 | 12" x 10" | 12" | 32" | 35-11/16" | 10" | 19-5/8" | 39" |
| YL-12181 | 12" | 12" | 36"*** | 40-3/4" | 12" | 21-27/32" | 43" |
| YL-14161 | 14" x 8" | 14" | 20" | 30" | 8" | 17-5/32" | 38" |
| YL-14171 | 14" x 10" | 14" | 32" | 36-11/32" | 10" | 20-5/8" | 42" |
| YL-14181 | 14" x 12" | 14" | 36"*** | 41-3/4" | 12" | 22-27/32" | 46" |
| YL-14191 | 14" | 14" | 36"*** | 45-15/16" | 14" | 24-13/32" | 52" |

STANDARD 45° YL'S

2-1/8" OD to 4" OD
16 GAUGE MATERIAL

5" OD to 8" OD
14 GAUGE MATERIAL

10" OD to 14" OD
12 GAUGE MATERIAL

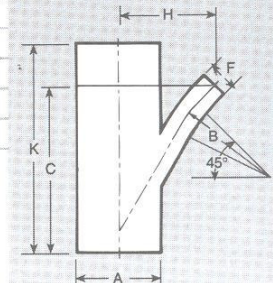
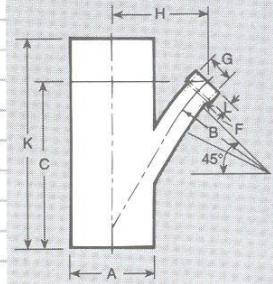

**Segmented

G Inside Diameter (ID) = F Outside Diameter (OD)
L Expansion Depth 1-1/4" thru 4" OD, 1-1/2" for 5" and 6" OD

All reference dimensions are nominal.
Catalog Part Variations Available Upon Request.

Expanded Ends standard through 6" size.

Straight Ends available on all sizes by request.

STANDARD DOUBLE Y'S

2-1/8" OD to 4" OD
16 GAUGE
MATERIAL

5" OD and 6" OD
14 GAUGE
MATERIAL

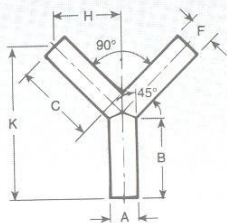
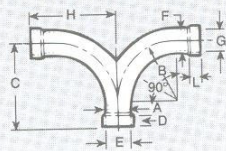
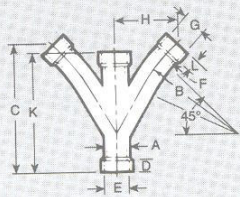
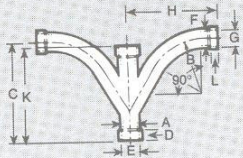

Expanded Ends standard*.
Straight and Expanded
combinations available.

Straight Ends available
on all sizes by request.

* Except Utility Y's



Standard Double Y's

11 Gauge Y's Available

STANDARD DOUBLE 90° TY'S

| PART NO. | SIZE | A(OD) | B | C | F(OD) | H | K |
|----------|--------|--------|---------|---------|--------|-----------|---------|
| DTY-215 | 2-1/8" | 2-1/8" | 5" | 9-5/32" | 2-1/8" | 8-13/16" | 9-1/2" |
| DTY-256 | 2-1/2" | 2-1/2" | 6" | 10-1/2" | 2-1/2" | 10-1/32" | 10" |
| DTY-307 | 3" | 3" | 7-1/2" | 12-3/8" | 3" | 11-25/32" | 11-1/2" |
| DTY-358 | 3-1/2" | 3-1/2" | 8-3/4" | 14-1/8" | 3-1/2" | 13-11/32" | 13" |
| DTY-409 | 4" | 4" | 10" | 15-7/8" | 4" | 14-29/32" | 14" |
| DTY-515 | 5" | 5" | 12-1/2" | 19-3/8" | 5" | 18-5/8" | 18-1/2" |
| DTY-615 | 6" | 6" | 15" | 22-7/8" | 6" | 22-11/32" | 21" |

STANDARD DOUBLE 45° YL'S

| PART NO. | SIZE | A(OD) | B | C | F(OD) | H | K |
|----------|--------|--------|---------|-----------|--------|-----------|---------|
| DYL-2151 | 2-1/8" | 2-1/8" | 5" | 9-3/32" | 2-1/8" | 4-11/16" | 9-1/2" |
| DYL-2561 | 2-1/2" | 2-1/2" | 6" | 10-5/32" | 2-1/2" | 5-3/16" | 10" |
| DYL-3071 | 3" | 3" | 7-1/2" | 11-19/32" | 3" | 5-29/32" | 11-1/2" |
| DYL-3581 | 3-1/2" | 3-1/2" | 8-3/4" | 12-31/32" | 3-1/2" | 6-9/16" | 13" |
| DYL-4091 | 4" | 4" | 10" | 14-11/32" | 4" | 7-1/4" | 14" |
| DYL-5151 | 5" | 5" | 12-1/2" | 17-9/16" | 5" | 9" | 18-1/2" |
| DYL-6151 | 6" | 6" | 15" | 20-25/32" | 6" | 10-15/32" | 21" |

STANDARD DOUBLE 90° Y'S

| PART NO. | SIZE | A(OD) | B | C | F(OD) | H | K |
|----------|--------|--------|---------|---------|--------|---------|---|
| DY-215 | 2-1/8" | 2-1/8" | 5" | 7" | 2-1/8" | 7" | - |
| DY-256 | 2-1/2" | 2-1/2" | 6" | 8" | 2-1/2" | 8" | - |
| DY-307 | 3" | 3" | 7-1/2" | 9-1/2" | 3" | 9-1/2" | - |
| DY-358 | 3-1/2" | 3-1/2" | 8-3/4" | 10-3/4" | 3-1/2" | 10-3/4" | - |
| DY-409 | 4" | 4" | 10" | 12" | 4" | 12" | - |
| DY-515 | 5" | 5" | 12-1/2" | 15-1/8" | 5" | 15-1/8" | - |
| DY-615 | 6" | 6" | 15" | 18-1/4" | 6" | 18-1/4" | - |

STANDARD UTILITY Y'S

| PART NO. | SIZE | A(OD) | B | C | F(OD) | H | K |
|----------|--------|--------|-----|-----|--------|-----------|-----------|
| UY-2151 | 2-1/8" | 2-1/8" | 6" | 6" | 2-1/8" | 5" | 11-7/16" |
| UY-2561 | 2-1/2" | 2-1/2" | 6" | 6" | 2-1/2" | 5-1/8" | 11-21/32" |
| UY-3071 | 3" | 3" | 6" | 6" | 3" | 5-5/16" | 11-15/16" |
| UY-3581 | 3-1/2" | 3-1/2" | 7" | 7" | 3-1/2" | 6-3/16" | 13-29/32" |
| UY-4091 | 4" | 4" | 8" | 8" | 4" | 7-1/16" | 15-29/32" |
| UY-5151 | 5" | 5" | 10" | 10" | 5" | 8-27/32" | 19-7/8" |
| UY-6151 | 6" | 6" | 12" | 12" | 6" | 10-19/32" | 23-27/32" |

D Expansion Depth 1-1/4" thru 4" OD, 1-1/2" for 5" and 6" OD
E Inside Diameter (ID) = A Outside Diameter (OD)
G Inside Diameter (ID) = F Outside Diameter (OD)
L Expansion Depth 1-1/4" thru 4" OD, 1-1/2" for 5" and 6" OD

All reference dimensions are nominal.
Catalog Part Variations Available Upon Request.



Standard Reducing Couplings

11 Gauge Reducing Couplings Available

STANDARD REDUCING COUPLINGS

| PART NO. | SIZE | A(OD) | GAUGE | C | D | E(ID) | GAUGE | K |
|----------|-----------------|--------|-------|---------|--------|--------|-------|--------|
| RC-212 | 2-1/8" x 2" | 2-1/8" | 16 | 4" | 1-1/8" | 2" | 16 | 2" |
| RC-254 | 2-1/2" x 2-1/8" | 2-1/2" | 16 | 4-1/2" | 1-1/4" | 2-1/8" | 16 | 1-1/2" |
| RC-3041 | 3" x 2-1/8" | 3" | 16 | 8-3/4" | 1-1/4" | 2-1/8" | 16 | 2" |
| RC-304 | 3" x 2-1/2" | 3" | 16 | 5" | 1-1/4" | 2-1/2" | 16 | 1-1/2" |
| RC-3541 | 3-1/2" x 2-1/8" | 3-1/2" | 16 | 11" | 1-1/4" | 2-1/8" | 16 | 2" |
| RC-3542 | 3-1/2" x 2-1/2" | 3-1/2" | 16 | 9-1/4" | 1-1/4" | 2-1/2" | 16 | 2-7/8" |
| RC-354 | 3-1/2" x 3" | 3-1/2" | 16 | 5-1/2" | 1-1/4" | 3" | 16 | 1-1/2" |
| RC-4041 | 4" x 2-1/8" | 4" | 16 | 13-1/2" | 1-1/4" | 2-1/8" | 16 | 2" |
| RC-4042 | 4" x 2-1/2" | 4" | 16 | 10-1/2" | 1-1/4" | 2-1/2" | 16 | 2" |
| RC-4043 | 4" x 3" | 4" | 16 | 9-1/4" | 1-1/4" | 3" | 16 | 2" |
| RC-404 | 4" x 3-1/2" | 4" | 16 | 6" | 1-1/4" | 3-1/2" | 16 | 1-1/2" |
| RC-5041 | 5" x 2-1/8" | 5" | 14 | 19-1/4" | 1-1/4" | 2-1/8" | 16 | 2-3/4" |
| RC-5042 | 5" x 2-1/2" | 5" | 14 | 17-1/2" | 1-1/4" | 2-1/2" | 16 | 2-3/4" |
| RC-5043 | 5" x 3" | 5" | 14 | 15" | 1-1/4" | 3" | 16 | 2-3/4" |
| RC-5044 | 5" x 3-1/2" | 5" | 14 | 12-1/2" | 1-1/4" | 3-1/2" | 16 | 2-3/4" |
| RC-504 | 5" x 4" | 5" | 16 | 8" | 1-1/4" | 4" | 16 | 1-3/4" |
| RC-6041 | 6" x 2-1/8" | 6" | 14 | 24-3/4" | 1-1/4" | 2-1/8" | 16 | 3-1/4" |
| RC-6042 | 6" x 2-1/2" | 6" | 14 | 23" | 1-1/4" | 2-1/2" | 16 | 3-1/4" |
| RC-6043 | 6" x 3" | 6" | 14 | 20-1/2" | 1-1/4" | 3" | 16 | 3-1/4" |
| RC-6044 | 6" x 3-1/2" | 6" | 14 | 18" | 1-1/4" | 3-1/2" | 16 | 3-1/4" |
| RC-6045 | 6" x 4" | 6" | 14 | 15-3/4" | 1-1/4" | 4" | 16 | 3-1/4" |
| RC-604 | 6" x 5" | 6" | 14 | 10" | 1-1/2" | 5" | 14 | 1-3/4" |
| RC-8044 | 8" x 4" | 8" | 14 | 26-1/4" | 1-1/4" | 4" | 16 | 4-1/4" |
| RC-8045 | 8" x 5" | 8" | 14 | 21-7/8" | 1-1/2" | 5" | 14 | 4-1/4" |
| RC-804 | 8" x 6" | 8" | 14 | 17-1/2" | 1-1/2" | 6" | 14 | 4-1/4" |
| RC-10046 | 10" x 6" | 10" | 12 | 28-1/2" | 1-1/2" | 6" | 14 | 5-1/4" |
| RC-1004 | 10" x 8" | 10" | 12 | 18-1/4" | 2-1/2" | 8" OD | 14 | 5-1/4" |
| RC-12048 | 12" x 8" | 12" | 12 | 29-1/4" | 2-1/2" | 8" OD | 14 | 6-1/4" |
| RC-1204 | 12" x 10" | 12" | 12 | 19-3/4" | 3" | 10" OD | 12 | 6-1/4" |
| RC-1404 | 14" x 10" | 14" | 12 | 30" | 3" | 10" OD | 12 | 7-1/4" |
| RC-1405 | 14" x 12" | 14" | 12 | 20" | 4" | 12" OD | 12 | 7-1/4" |

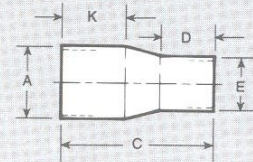
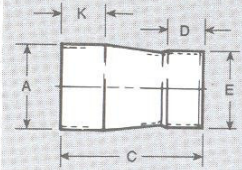

OD = Outside Diameter
ID = Inside Diameter

All reference dimensions are nominal.
Catalog Part Variations Available Upon Request.

Expanded Ends standard through 6" size (on small end of reducer).

Straight Ends available on all sizes by request.

STANDARD ADAPTERS



Standard Adapters

11 Gauge Adapters Available

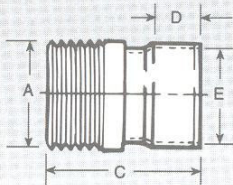
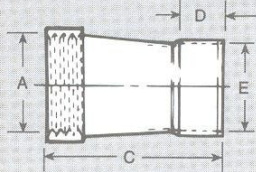
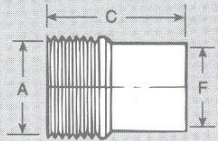
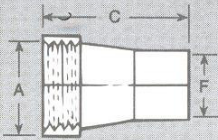

OD = Outside Diameter
 ID = Inside Diameter
 FNPT = Female Nominal Pipe Thread.
 MNPT = Male Nominal Pipe Thread.

All reference dimensions are nominal.
 Catalog Part Variations Available Upon Request.

FEMALE ADAPTERS

| PART NO. | SIZE | A-FNPT | C | F(OD) | GAUGE |
|----------|------------------|--------|--------|--------|-------|
| FA-201 | 2" to 2" | 2" | 6" | 2" | 16 |
| FA-211 | 2" to 2-1/8" | 2" | 6" | 2-1/8" | 16 |
| FA-251 | 2-1/2" to 2-1/2" | 2-1/2" | 6" | 2-1/2" | 16 |
| FA-301 | 3" to 3" | 3" | 6" | 3" | 16 |
| FA-351 | 3-1/2" to 3-1/2" | 3-1/2" | 6" | 3-1/2" | 16 |
| FA-401 | 4" to 4" | 4" | 6-1/2" | 4" | 16 |
| FA-501 | 5" to 5" | 5" | 6-3/4" | 5" | 14 |
| FA-601 | 6" to 6" | 6" | 7" | 6" | 14 |
| FA-801 | 8" to 8" | 8" | 9" | 8" | 14 |
| FA-1001 | 10" to 10" | 10" | 11" | 10" | 12 |
| FA-1201 | 12" to 12" | 12" | 13" | 12" | 12 |

MALE ADAPTERS

| PART NO. | SIZE | A-MNPT | C | F(OD) | GAUGE |
|----------|------------------|--------|--------|--------|-------|
| MA-202 | 2" to 2" | 2" | 6" | 2" | 16 |
| MA-212 | 2" to 2-1/8" | 2" | 6" | 2-1/8" | 16 |
| MA-252 | 2-1/2" to 2-1/2" | 2-1/2" | 6" | 2-1/2" | 16 |
| MA-302 | 3" to 3" | 3" | 6" | 3" | 16 |
| MA-352 | 3-1/2" to 3-1/2" | 3-1/2" | 6" | 3-1/2" | 16 |
| MA-402 | 4" to 4" | 4" | 6" | 4" | 16 |
| MA-502 | 5" to 5" | 5" | 6-1/2" | 5" | 14 |
| MA-602 | 6" to 6" | 6" | 7" | 6" | 14 |
| MA-802 | 8" to 8" | 8" | 8" | 8" | 14 |
| MA-1002 | 10" to 10" | 10" | 8-1/2" | 10" | 12 |
| MA-1202 | 12" to 12" | 12" | 9" | 12" | 12 |

FEMALE ADAPTER EXPANDED

| PART NO. | SIZE | A-FNPT | C | D | E(ID) | GAUGE |
|----------|------------------|--------|--------|--------|--------|-------|
| FA-203 | 2" to 2" | 2" | 4" | 1-1/8" | 2" | 16 |
| FA-213 | 2" to 2-1/8" | 2" | 4" | 1-1/4" | 2-1/8" | 16 |
| FA-253 | 2-1/2" to 2-1/2" | 2-1/2" | 5" | 1-1/4" | 2-1/2" | 16 |
| FA-303 | 3" to 3" | 3" | 5-1/4" | 1-1/4" | 3" | 16 |
| FA-353 | 3-1/2" to 3-1/2" | 3-1/2" | 5-1/2" | 1-1/4" | 3-1/2" | 16 |
| FA-403 | 4" to 4" | 4" | 6-1/2" | 1-1/4" | 4" | 16 |
| FA-503 | 5" to 5" | 5" | 6-3/4" | 1-1/2" | 5" | 14 |
| FA-603 | 6" to 6" | 6" | 7" | 1-1/2" | 6" | 14 |

MALE ADAPTER EXPANDED

| PART NO. | SIZE | A-MNPT | C | D | E(ID) | GAUGE |
|----------|------------------|--------|--------|--------|--------|-------|
| MA-204 | 2" to 2" | 2" | 4" | 1-1/8" | 2" | 16 |
| MA-214 | 2" to 2-1/8" | 2" | 4" | 1-1/4" | 2-1/8" | 16 |
| MA-254 | 2-1/2" to 2-1/2" | 2-1/2" | 4" | 1-1/4" | 2-1/2" | 16 |
| MA-304 | 3" to 3" | 3" | 4-3/4" | 1-1/4" | 3" | 16 |
| MA-354 | 3-1/2" to 3-1/2" | 3-1/2" | 4-3/4" | 1-1/4" | 3-1/2" | 16 |
| MA-404 | 4" to 4" | 4" | 4-3/4" | 1-1/4" | 4" | 16 |
| MA-504 | 5" to 5" | 5" | 5" | 1-1/2" | 5" | 14 |
| MA-604 | 6" to 6" | 6" | 5-1/4" | 1-1/2" | 6" | 14 |



Standard Adapters

11 Gauge Adapters Available

STANDARD ADAPTERS

90° ADAPTER ELBOWS

| PART NO. | SIZE | C | D | E(ID) | H | L-FNPT |
|----------|--------------|---------|---------|--------|--------|--------|
| AE-211* | 2-1/8" to 2" | 2-9/16" | 1-1/16" | 2-1/8" | 1-5/8" | 2" |

**Available only in Cast Gray Iron, Zinc, Nickel Plated, or Cast Aluminum.*

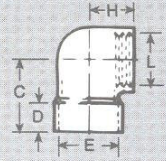

ADAPTER TEES

| PART NO. | SIZE | C | D | E(ID) | H | L-FNPT |
|----------|--------------|----------|---------|--------|---------|--------|
| AT-212* | 2-1/8" to 2" | 4-13/16" | 1-1/16" | 2-1/8" | 1-9/16" | 2" |
| AT-250 | 2-1/2" to 2" | 6-1/2" | 1-1/4" | 2-1/2" | 2-1/8" | 2" |
| AT-302 | 3" to 2" | 6-1/2" | 1-1/4" | 3" | 2-3/4" | 2" |
| AT-352 | 3-1/2" to 2" | 6-7/8" | 1-1/4" | 3-1/2" | 3-7/16" | 2" |
| AT-402 | 4" to 2" | 6-7/8" | 1-1/4" | 4" | 3-7/16" | 2" |

**Available only in Cast Gray Iron, Zinc, Nickel Plated, or Cast Aluminum.*

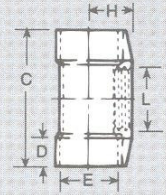

MALE ADAPTERS

| PART NO. | SIZE | A-MNPT | C | D | F(ID) | F(OD) |
|----------|-----------------|--------|--------|---------|--------|--------|
| MA-16 | 2-1/8" x 1-1/4" | 1-1/4" | 5-3/4" | - | - | 2-1/8" |
| MA-17 | 2-1/8" x 1-1/2" | 1-1/2" | 5-3/4" | - | - | 2-1/8" |
| MA-18 | 2-1/8" x 1-1/4" | 1-1/4" | 5-3/4" | 1-1/4"* | 2-1/8" | - |
| MA-19 | 2-1/8" x 1-1/2" | 1-1/2" | 5-3/4" | 1-1/4"* | 2-1/8" | - |

**Expansion Depth*

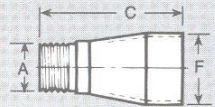

MALE ADAPTER NIPPLE

| PART NO. | SIZE | A-MNPT | C | E(ID) |
|----------|--------|--------|----|--------|
| MA-20 | 2-1/8" | 2" | 2" | 2-1/8" |

FEMALE REDUCING ADAPTER

| PART NO. | SIZE | A-FNPT | C | F(OD) | GAUGE |
|----------|--------------|--------|--------|--------|-------|
| FA-205 | 2" to 2-1/2" | 2" | 4-1/4" | 2-1/2" | 16 |

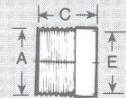

FEMALE REDUCING ADAPTER EXPANDED

| PART NO. | SIZE | A-FNPT | C | D | E(ID) | GAUGE |
|----------|--------------|--------|--------|--------|--------|-------|
| FA-206 | 2" to 2-1/2" | 2" | 4-1/4" | 1-1/4" | 2-1/2" | 16 |

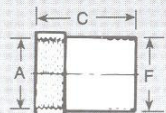

45° FEMALE ADAPTER ELBOW

| PART NO. | SIZE | A(OD) GAUGE | B | C | D | E(ID) | F | L-FNPT |
|----------|------------------|-------------|----|---------|--------|--------|---------|--------|
| AE-2111 | 2-1/8" to 2" | 2-1/8" - 16 | 5" | 4-1/16" | 1-1/4" | 2-1/8" | 4-1/16" | 2" |
| AE-2511 | 2-1/2" to 2" | 2-1/2" - 16 | 6" | 4-1/2" | 1-1/4" | 2-1/2" | 4-1/2" | 2" |
| AE-2512 | 2-1/2" to 2-1/2" | 2-1/2" - 16 | 6" | 4-1/2" | 1-1/4" | 2-1/2" | 4-1/2" | 2-1/2" |

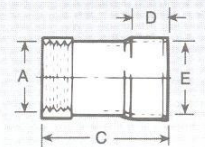

FNPT = Female Nominal Pipe Thread
 MNPT = Male Nominal Pipe Thread
 OD = Outside Diameter
 ID = Inside Diameter

All reference dimensions are nominal.
 Catalog Part Variations Available Upon Request.

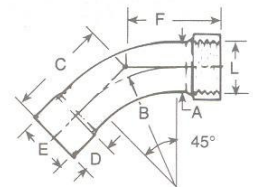

METHODS OF JOINING



Methods of Joining

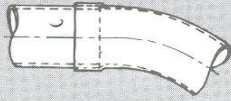

Expanded Fitting

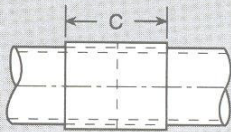

Slip Coupling

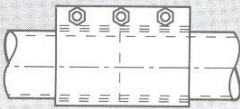

Compression Coupling

Joining methods are for use in low pressure (under 15 PSIG) systems. Slotted joining method also available.

OD = Outside Diameter
ID = Inside Diameter
PSIG = Pounds per Square Inch Gravity

All reference dimensions are nominal.

Catalog Part Variations Available upon Request.

EXPANDED FITTINGS

This type of connection enables a straight section of tubing to slip inside the expanded end of the fitting. The two pieces can then be "locked" together by any one of several techniques - brazing, welding, industrial adhesive, or shrink sleeve.

Note: This method is not available in 11 gauge material.

SLIP COUPLINGS

Can be used for joining any two straight ends of tubing or fittings. The slip coupling is a solid sleeve that fits the OD of the joint which can then be glued, brazed, welded, or covered by a shrink sleeve.

| PART NO. | SIZE | C | ID | GAUGE |
|----------|--------|--------|--------|-------|
| SC-213 | 2-1/8" | 3" | 2-1/8" | 16 |
| SC-253 | 2-1/2" | 3-1/2" | 2-1/2" | 16 |
| SC-303 | 3" | 4" | 3" | 16 |
| SC-353 | 3-1/2" | 4-1/2" | 3-1/2" | 16 |
| SC-403 | 4" | 5" | 4" | 16 |
| SC-503 | 5" | 6" | 5" | 14 |
| SC-603 | 6" | 7" | 6" | 14 |
| SC-803 | 8" | 8" | 8" | 14 |
| SC-1003 | 10" | 10" | 10" | 12 |
| SC-1203 | 12" | 12" | 12" | 12 |
| SC-1403 | 14" | 14" | 14" | 12 |

COMPRESSION COUPLINGS

Offers easy "tear down" function. Straight end tubing or fittings butt together within the ID of the coupling, and the joint is mechanically locked simply by tightening the bolts which are attached.

WITH BLACK NEOPRENE LINER & STAINLESS STEEL GROUNDING STRIP

| PART NO. | TUBE OD | NO. OF BOLTS | COUPLING LENGTH | WEIGHT LBS. |
|-----------|---------|--------------|-----------------|-------------|
| 21253B10 | 2-1/8" | 3 | 6" | 3.2 |
| 25003B10 | 2-1/2" | 3 | 6" | 3.4 |
| 30003B10 | 3" | 3 | 6" | 4.5 |
| 35003B10 | 3-1/2" | 3 | 6" | 5.1 |
| 40003B10 | 4" | 3 | 6" | 5.3 |
| 50004B10 | 5" | 4 | 8" | 8.1 |
| 60004B10 | 6" | 4 | 8" | 9.4 |
| 80004B10 | 8" | 4 | 10" | 18.0 |
| 100004B10 | 10" | 4 | 10" | 21.8 |
| 120004B10 | 12" | 4 | 10" | 25.2 |
| 140004B10 | 14" | 4 | 10" | 27.6 |



Methods of Joining

SHRINK SLEEVES

A heat shrinkable polyolefin band that literally shrinks and encircles the connection giving it mechanical strength and a positive seal. It can be used in conjunction with a slip coupling or when using expanded fittings. Gluing, brazing and welding operations are eliminated.

| PART NO. | FOR TUBE OD SIZE | SLEEVE LENGTH |
|----------|------------------|---------------|
| SS-212 | 2" - 2-1/8" | 4" |
| SS-300 | 2-1/2" - 3" | 4" |
| SS-350 | 3-1/2" | 4" |
| SS-400 | 4" | 4" |
| SS-500 | 5" | 4" |
| SS-600 | 6" | 4" |
| SS-800 | 8" | 9" |
| SS-1000 | 10" | 9" |
| SS-1200 | 12" | 9" |

ADHESIVE

| PART NO. | AMOUNT |
|----------|--------|
| 2863 | PINT |
| 2864 | QUART |

THINNER (M.E.K.)

| PART NO. | AMOUNT |
|----------|--------|
| 2868 | QUART |

SLIP WELDING RINGS*

| PART NO. | SIZE | C | E(ID) | GAUGE |
|----------|------|----|-------|-------|
| WR-8035 | 8" | 3" | 8" | 14 |
| WR-10035 | 10" | 3" | 10" | 12 |
| WR-12035 | 12" | 3" | 12" | 12 |
| WR-14035 | 14" | 3" | 14" | 12 |

OD = Outside Diameter

ID = Inside Diameter

* These parts available in
11 Gauge material

All reference dimensions are nominal.
Catalog Part Variations Available Upon Request.

TUBE HANGERS

| PART NO. | SIZE | E(ID) | GAUGE |
|----------|--------|--------|-------|
| TH-212 | 2-1/8" | 2-1/8" | 16 |
| TH-250 | 2-1/2" | 2-1/2" | 16 |
| TH-300 | 3" | 3" | 16 |
| TH-350 | 3-1/2" | 3-1/2" | 16 |
| TH-400 | 4" | 4" | 16 |
| TH-500 | 5" | 5" | 16 |
| TH-600 | 6" | 6" | 16 |
| TH-800 | 8" | 8" | 16 |
| TH-1000 | 10" | 10" | 16 |
| TH-1200 | 12" | 12" | 16 |
| TH-1400 | 14" | 14" | 16 |

Available only in Zinc-coated (galvanized) steel.

TUBE PLUGS*

| PART NO. | SIZE | A(OD) | GAUGE | C |
|----------|--------|--------|-------|--------|
| TP-210 | 2-1/8" | 2-1/8" | 16 | 1-3/8" |
| TP-260 | 2-1/2" | 2-1/2" | 16 | 1-3/8" |
| TP-310 | 3" | 3" | 16 | 1-3/8" |
| TP-360 | 3-1/2" | 3-1/2" | 16 | 1-3/8" |
| TP-410 | 4" | 4" | 16 | 1-3/8" |
| TP-510 | 5" | 5" | 14 | 1-5/8" |
| TP-610 | 6" | 6" | 14 | 1-5/8" |
| TP-810 | 8" | 8" ID | 14 | 1-3/4" |
| TP-1010 | 10" | 10" ID | 12 | 2" |
| TP-1210 | 12" | 12" ID | 12 | 2" |
| TP-1410 | 14" | 14" ID | 12 | 2" |

TUBE NIPPLES*

| PART NO. | SIZE | A(OD) | GAUGE | C |
|----------|--------|--------|-------|--------|
| TN-211 | 2-1/8" | 2-1/8" | 16 | 2-1/2" |
| TN-261 | 2-1/2" | 2-1/2" | 16 | 2-1/2" |
| TN-311 | 3" | 3" | 16 | 2-1/2" |
| TN-361 | 3-1/2" | 3-1/2" | 16 | 2-1/2" |
| TN-411 | 4" | 4" | 16 | 2-1/2" |
| TN-511 | 5" | 5" | 14 | 3" |
| TN-611 | 6" | 6" | 14 | 3" |
| TN-811 | 8" | 8" | 14 | 4" |
| TN-1011 | 10" | 10" | 12 | 5" |
| TN-1211 | 12" | 12" | 12 | 6" |
| TN-1411 | 14" | 14" | 12 | 7" |

METHODS OF JOINING

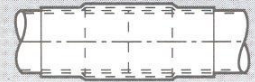

Shrink Sleeve

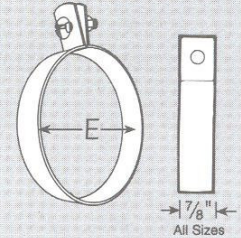

Tube Hanger

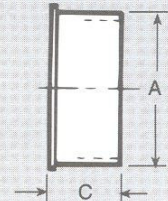

Tube Plug

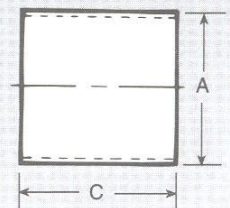

Tube Nipple

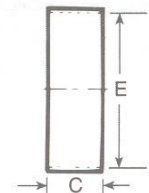

Welding Ring

INLET VALVES FOR VACUUM SYSTEMS



Inlet Valves For Vacuum Systems

Floor Valves Available

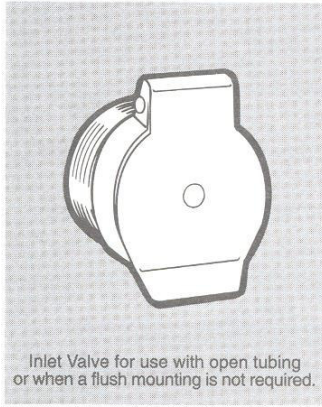

Inlet Valve for use with open tubing or when a flush mounting is not required.

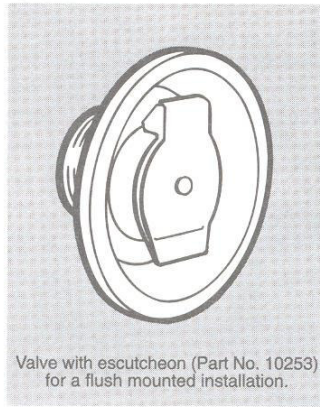

Valve with escutcheon (Part No. 10253) for a flush mounted installation.

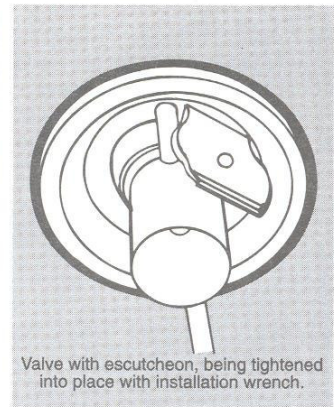

Valve with escutcheon, being tightened into place with installation wrench.

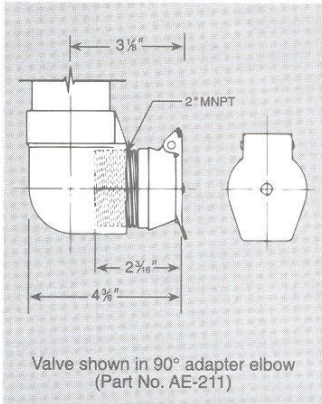

Valve shown in 90° adapter elbow (Part No. AE-211)

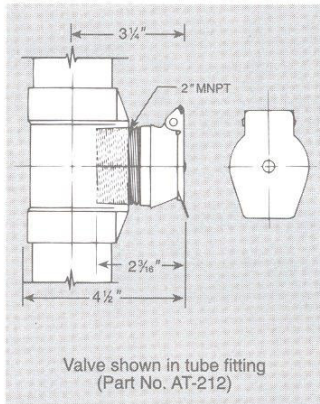

Valve shown in tube fitting (Part No. AT-212)

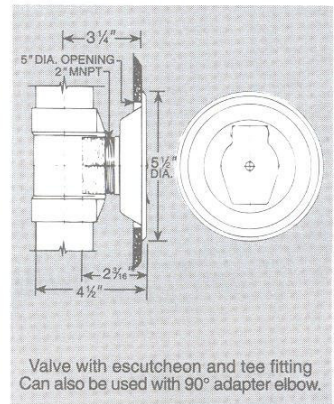

Valve with escutcheon and tee fitting Can also be used with 90° adapter elbow.

OD = Outside Diameter
ID = Inside Diameter

FNPT = Female Nominal Pipe Thread

MNPT = Male Nominal Pipe Thread

*All reference dimensions are nominal.
Catalog Part Variations Available Upon Request.*

Heavy duty inlet valves provide for a quick connection of the male hose coupling to the vacuum cleaning system. These parts are designed for insertion into a 2" FNPT threaded fitting adapting to a 2-1/8" tube size. Valves have self-closing covers and are available in galvanized and stainless steel, as well as nickel plated models. The electric switch option allows for convenient operation of the system at the work location. Escutcheon plates allow for a more attractive wall installation.

The same body is used for all three valves... only the bore varies. IV-150 and IV-200 use a slight taper for hose adapter retention. IV-180 utilizes a clip on the valve lid for retention instead. Hose adapters are constructed of heavy-duty galvanized steel.

INLET VALVES*

| PART NO. | BORE | MNPT |
|----------|------|------|
| IV-150 | 1.5" | 2.0" |
| IV-180 | 1.8" | 2.0" |
| IV-200 | 2.0" | 2.0" |

* Also Available with Low Voltage Switch

ESCUTCHEON PLATES

| PART NO. | TYPE |
|----------|-----------|
| 10253 | ZINC |
| 23939 | STAINLESS |

| INLET VALVE PART NO. | WRENCH PART NO. | HOSE ADAPTER PART NO. | FOR HOSE SIZE |
|--------------------------------------|-----------------|-----------------------|---------------|
| IV-150 accepts 1-1/2"OD Hose Adapter | VW-150 | HA-150 | 1-1/2" ID |
| IV-180 accepts 1.8"OD Hose Adapter | VW-180 | HA-180 | 1-1/2" ID |
| IV-200 accepts 2"OD Hose Adapter | VW-180 | HA-200 | 2" ID |



Standard Long Radius Bends

STANDARD LONG RADIUS BENDS

| A | B | 45° | C | 90° | C | GAUGE |
|--------|-----|-------------|-----------|-------------|-----|-------|
| OD | CLR | PART NO. | | PART NO. | | |
| 2-1/8" | 24" | 16-212241 | 15-15/16" | 16-212242 | 30" | 16 |
| 2-1/8" | 24" | 11-212241 | 15-15/16" | 11-212242 | 30" | 11 |
| 2-1/8" | 36" | 16-212361 | 20-15/16" | 16-212362 | 42" | 16 |
| 2-1/8" | 36" | 11-212361 | 20-15/16" | 11-212362 | 42" | 11 |
| 2-1/2" | 24" | 16-250241 | 15-15/16" | 16-250242 | 30" | 16 |
| 2-1/2" | 24" | 11-250241 | 15-15/16" | 11-250242 | 30" | 11 |
| 2-1/2" | 36" | 16-250361 | 20-15/16" | 16-250362 | 42" | 16 |
| 2-1/2" | 36" | 11-250361 | 20-15/16" | 11-250362 | 42" | 11 |
| 3" | 24" | 16-300241 | 15-15/16" | 16-300242 | 30" | 16 |
| 3" | 24" | 11-300241 | 15-15/16" | 11-300242 | 30" | 11 |
| 3" | 30" | 16-300301 | 18-7/16" | 16-300302 | 36" | 16 |
| 3" | 30" | 11-300301 | 18-7/16" | 11-300302 | 36" | 11 |
| 3" | 36" | 16-300361 | 20-15/16" | 16-300362 | 42" | 16 |
| 3" | 36" | 11-300361 | 20-15/16" | 11-300362 | 42" | 11 |
| 3" | 38" | 16-300381 | 21-3/4" | 16-300382 | 44" | 16 |
| 3" | 38" | 11-300381 | 21-3/4" | 11-300382 | 44" | 11 |
| 3" | 48" | 16-300481 | 25-7/8" | 16-300482 | 54" | 16 |
| 3" | 48" | 11-300481 | 25-7/8" | 11-300482 | 54" | 11 |
| 3-1/2" | 30" | 16-350301 | 19-7/16" | 16-350302 | 37" | 16 |
| 3-1/2" | 30" | 11-350301 | 19-7/16" | 11-350302 | 37" | 11 |
| 3-1/2" | 36" | 16-350361 | 21-15/16" | 16-350362 | 43" | 16 |
| 3-1/2" | 36" | 11-350361 | 21-15/16" | 11-350362 | 43" | 11 |
| 3-1/2" | 48" | 16-350481 | 26-7/8" | 16-350482 | 55" | 16 |
| 3-1/2" | 48" | 11-350481 | 26-7/8" | 11-350482 | 55" | 11 |
| 4" | 24" | 16-400241 | 17-15/16" | 16-400242 | 32" | 16 |
| 4" | 24" | 11-400241 | 17-15/16" | 11-400242 | 32" | 11 |
| 4" | 30" | 16-400301 | 20-7/16" | 16-400302 | 38" | 16 |
| 4" | 30" | 11-400301 | 20-7/16" | 11-400302 | 38" | 11 |
| 4" | 36" | 16-400361 | 22-15/16" | 16-400362 | 44" | 16 |
| 4" | 36" | 11-400361 | 22-15/16" | 11-400362 | 44" | 11 |
| 4" | 48" | 16-400481 | 27-7/8" | 16-400482 | 56" | 16 |
| 4" | 48" | 11-400481 | 27-7/8" | 11-400482 | 56" | 11 |
| 4" | 60" | 16-400601 | 32-7/8" | 16-400602 | 68" | 16 |
| 4" | 60" | 11-400601 | 32-7/8" | 11-400602 | 68" | 11 |
| 5" | 30" | 14-500301 | 22-7/16" | 14-500302 | 40" | 14 |
| 5" | 30" | 11-500301 | 22-7/16" | 11-500302 | 40" | 11 |
| 5" | 48" | 14-500481 | 29-7/8" | 14-500482 | 58" | 14 |
| 5" | 48" | 11-500481 | 29-7/8" | 11-500482 | 58" | 11 |
| 6" | 30" | 14-600301 | 24-7/16" | 14-600302 | 42" | 14 |
| 6" | 30" | 11-600301 | 24-7/16" | 11-600302 | 42" | 11 |
| 6" | 48" | 14-600481 | 31-7/8" | 14-600482 | 60" | 14 |
| 6" | 48" | 11-600481 | 31-7/8" | 11-600482 | 60" | 11 |
| 6" | 60" | 14-600601 | 36-7/8" | 14-600602 | 72" | 14 |
| 6" | 60" | 11-600601 | 36-7/8" | 11-600602 | 72" | 11 |
| 8" | 32" | 14-800321 | 25-1/4" | 14-800322 | 48" | 14 |
| 8" | 32" | 11-800321 | 25-1/4" | 11-800322 | 48" | 11 |
| 8" | 48" | 14-800481 | 31-7/8" | 14-800482 | 64" | 14 |
| 8" | 48" | 11-800481 | 31-7/8" | 11-800482 | 64" | 11 |
| 10" | 48" | 12-1000481* | 41-7/8" | 12-1000482* | 70" | 12 |

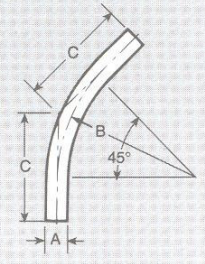
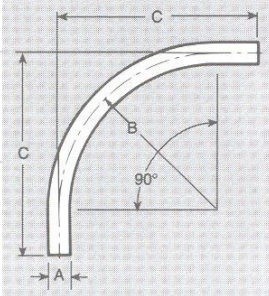

All standard bends have straight ends. Expanded ends are available upon request, except on 8" and 10" bends.

Nominal Standard Tangent is Two Times Tube OD, 6" minimum.

OD = Outside Diameter
CLR = Center Line Radius

All reference dimensions are nominal.
Catalog Part Variations Available Upon Request.

* Stainless Parts are Segmented
Nominal Standard Tangent for 10" Bend is 22"



Bend Information

TUBE BENDING CAPABILITIES

| OD (Inches) | Center Line Radius (Inches) | Gauge | Wall Thickness (Inches) |
|-------------|---|--------------------|------------------------------|
| 1/2 | 3-1/4, 17-5/8 | 16, 18, 20 | .065, .049, .035 |
| 5/8 | 1-5/16 | 16, 18, 20 | .065, .049, .035 |
| 3/4 | 2, 2-1/2, 3 | 16, 18, 20 | .065, .049, .035 |
| 7/8 | 2-1/2, 4, 18 | 16, 18, 20 | .065, .049, .035 |
| 1 | 1-1/4, 1-1/2, 1-3/4, 2-1/2, 3, 3-1/2, 4-1/2, 8-3/16, 12 | 11, 13, 14, 16, 18 | .120, .095, .083, .065, .049 |
| 1-1/8 | 1-1/2, 2-1/2 | 11, 14, 16, 18 | .120, .083, .065, .049 |
| 1-1/4 | 2-1/2, 3, 4, 5-1/2, 12, 15, 18, | 16, 22 | .065, .028 |
| 1-1/2 | 1-3/4, 2-1/2, 3, 3-1/4, 4, 12, 18, 36 | 11, 14, 16, 18 | .120, .083, .065, .049 |
| 1-5/8 | 2-1/8 | 16 | .065 |
| 1-3/4 | 2-1/2, 4-1/2, 36 | 11, 16 | .120, .065 |
| 2 | 2, 2-1/2, 3, 4, 5, 8, 12, 18, 24, 36 | 11, 16, 18, 20 | .120, .065, .049, .035 |
| 2-1/8 | 2-7/8, 3-1/2, 4-1/4, 5, 24, 36 | 11, 16 | .120, .065 |
| 2-1/4 | 2-1/2, 3, 4, 5-1/2, 8, 18, 24, 36, 42 | 11, 13, 16, 18, 20 | .120, .095, .065, .049, .035 |
| 2-3/8 | 2-3/8, 6, 8 | 16, 18 | .065, .049 |
| 2-1/2 | 2-1/2, 3-1/4, 3-3/4, 4, 5, 6, 24, 36 | 11, 13, 14, 16, 18 | .120, .095, .083, .065, .049 |
| 2-3/4 | 2-3/4, 3-7/8 | 16, 18 | .065, .049 |
| 2-7/8 | 10, 10-1/2 | 15, 16 | .072, .065 |
| 3 | 3, 4-1/2, 6, 7-1/2, 24, 30, 36, 38, 48 | 11, 12, 13, 16, 18 | .120, .109, .095, .065, .049 |
| 3-1/8 | 6 | 16 | .065 |
| 3-1/2 | 4, 5, 8, 8-3/4, 12, 13, 30, 36, 48 | 11, 14, 15, 16, 18 | .120, .083, .072, .065, .049 |
| 4 | 4, 6, 8, 9, 10, 24, 30, 36, 48, 60 | 10, 11, 14, 16, 18 | .134, .120, .083, .065, .049 |
| 4-1/2 | 16, 20, 24, 30, 48, 60 | 11, 14, 16 | .120, .083, .065 |
| 5 | 7-1/2, 12-1/2, 30, 48 | 10, 11, 14, 16 | .134, .120, .083, .065 |
| 6 | 9, 15, 30, 48, 60 | 10, 11, 14, 16 | .134, .120, .083, .065 |
| 8 | 12, 20, 32, 48 | 7, 11, 14 | .180, .120, .083 |
| 10 | 32, 48 | 11, 12 | .120, .109 |
| 4 x 7 Oval | 48 Flat, 48 Edge | 16 | .065 |
| 2 x 3 Rect. | 7 Flat | | .250 |
| 1 x 2 Rect. | 3-1/2 Flat | 16 | .065 |
| 1-1/4 Sq. | 4-7/8 | 16 | .065 |

PIPE BENDING CAPABILITIES

| Pipe Size (Inches) | OD (Inches) | Center Line Radius (Inches) | Schedule (Inches) | Other (Inches) |
|--------------------|-------------|------------------------------|-----------------------------|----------------|
| 3/4 | 1.050 | 3, 3-1/16 | 5(.065), 10(.083), 40(.113) | |
| 1 | 1.315 | 3 | 40(.133) | |
| 1-1/4 | 1.660 | 5, 12, 18 | 40(.140) | |
| 1-1/2 | 1.900 | 6, 12 | 40(.145) | .200 |
| 2 | 2.375 | 6, 8 | 5(.065), 40(.154) | .218 |
| 2-1/2 | 2.875 | 10, 10-1/2 | 40(.203) | |
| 3 | 3.500 | 5, 8-3/4, 12, 13, 30, 36, 48 | 5(.083), 10(.120), 40(.216) | .188 |
| 3-1/2 | 4.000 | 6, 9, 10, 24, 30, 36, 48, 60 | 5(.083), 10(.120) | |
| 4 | 4.500 | 16, 20, 24, 30, 48, 60 | 5(.083), 10(.120), 40(.237) | .188, .337 |
| 6 | 6.625 | 24 | 10(.134), 40(.280) | .188, .250 |
| 8 | 8.625 | 32 | 40(.322) | .188, .250 |



AMERICAN VACUUM COMPANY

7301 N. Monticello Ave. • Skokie, IL 60076 • Phone: 800-321-2849 • Fax: 847-674-0214